

altecnic DeltaSol[®] BS

Mounting
Connection
Handling
Fault localization
Examples

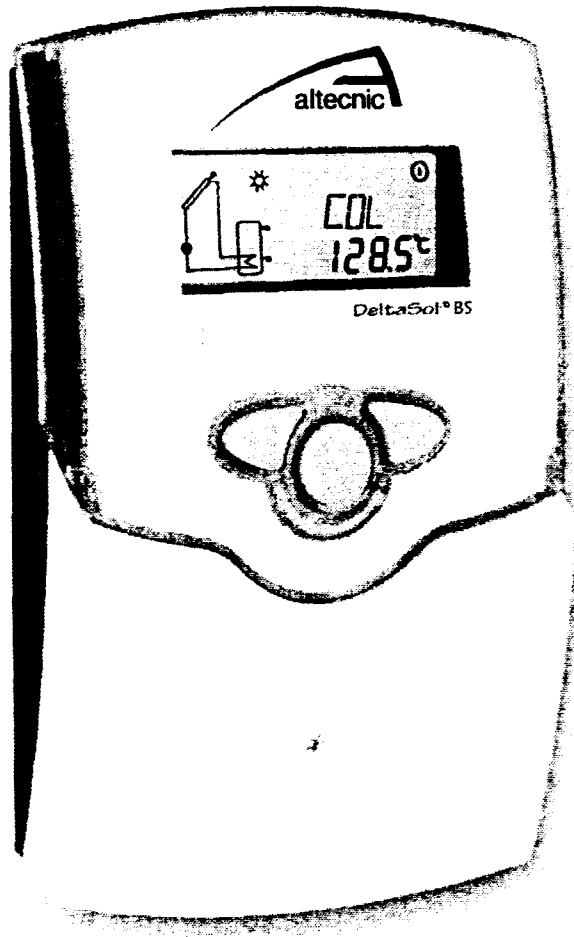

49002340

Thanks for buying a product.
Read this manual carefully to get the best performance from this unit.



manual

Security advice

Please pay attention to the following security advice in order to avoid danger and damage to people and property.

Instructions

Attention should be paid

- to the statutory provisions for prevention of industrial accidents,
- to the statutory provisions for environmental protection,
- to the Health and Safety at Work Act 1974
- to Part P of the Building Regulations 2005
- to BS7671 Requirements for electrical installations and relevant safety regulations of DIN, EN, DVGW, TRGI, TRF and VDE.

This instruction is exclusively addressed to authorised skilled personnel.

- Only qualified electricians should carry out electrical works.
- Initial installation should be effected by named qualified personnel

Contents

Security devices	2
Technical data and function survey	3
1. Installation	5
1.1 Mounting.....	5
1.2 Electrical wiring.....	5
1.2.1 Standard solar system.....	6
1.2.2 Solar system and after-heating.....	6
2. Operation and function	7
2.1 Adjustment buttons	7
2.2 System monitoring display	7
2.2.1 Channel indication.....	7
2.2.2 Tool bar.....	7
2.2.3 System screen.....	8
2.3 Blinkcodes	8
2.3.1 System-Screen Blinkcodes	8
2.3.2 Blinking codes	8
3. Commissioning	9
4. Control parameter and indication channels	10
4.1 Channel overview.....	10
4.1.1-6 Indication channels	11
4.1.7-19 Adjustment channels.....	12
5. Tips for fault localization	17
5.1 Miscellaneous.....	18
6. Accessory	20
Imprint	20

Declaration of conformity

We, Altecnic Ltd., declare under our sole responsibility that our product DeltaSol BS complies with the following standards:

EN 55 014-1

EN 60 730-1

According to the regulations of the above directives, the product is labelled with



89/336/EWG

73/ 23/EWG

- system-monitoring-display
- up to 4 temperature sensors Pt1000
- heat balancing
- function control
- user-friendly operation by simple handling
- pump speed control, solar operating hours counter and thermostat function optionally

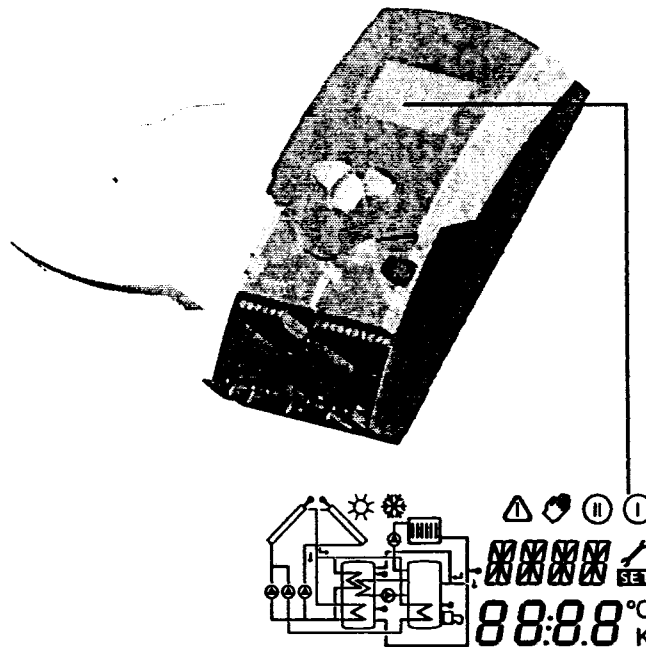

Scope of delivery:

- 1 x DeltaSol® BS
- 1 x accessory bag
 - 1 x spare fuse T4A
 - 2 x screws and dowels
 - 4 x strain relief and screws

Additionally enclosed in the full kit:

- 1 x sensor FKP6
- 2 x sensor FRP6

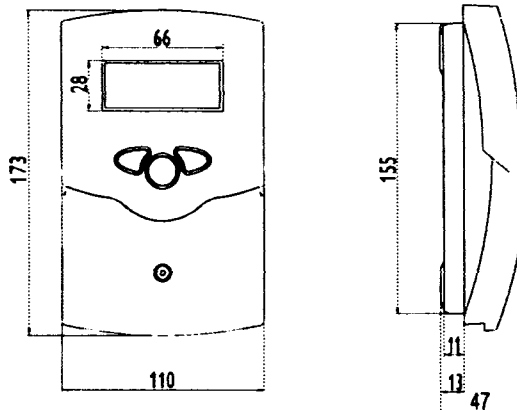

Controller version PG	Semiconductor relay	Standard relais	Operation hours counter	Speed control	Thermostat function	Heat balancing
66.30	0	1	yes	no	no	yes
67.30	1	0	yes	yes	no	yes
68.30	0	2	yes	no	yes	yes
69.30	1	1	yes	yes	yes	yes

Technical data

Housing:

plastic, PC-ABS and PMMA

Protection type: IP 20 / DIN 40050

Environmental temp.: 0 ... 40 °C

Size: 172 x 110 x 46 mm

Mounting: wall mounting, mounting into patch-panels is possible

Display: System screen for systems visualisation, 16-segment display, 7-segment display, 8 symbols for system status and operating control lamp

Operation: by 3 pushbuttons in the front of the housing

Functions: Temperature differential controller with optional add-on system functions. Function control according to BAW-guidelines, operating hours counter for solar pump, tube collector special function, pump speed control (PG 67.30 and PG 69.30) as well as heat quantity balancing.

Inputs: for 4 temperature sensors Pt1000

Outputs: depending on version, see survey „controller versions“

Power supply:

220 ... 240 V~

Mode of operation:

Typ 1.b (version 66.30, 68.30)

Typ 1.y (version 67.30, 69.30)

Breaking capacity per relay:

semi-conductor relay:

1 (1) A (220 ... 240) V~

electromechanical relay:

2 (1) A (220 ... 240) V~



Examples DeltaSol® BS

Standard solar systems

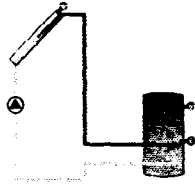

Solar systems with after-heating (68.30/69.30)

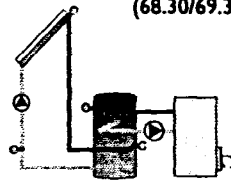

Please find detailed connection schemes for the shown systems in chapter 1.

1. Installation

1.1 Mounting

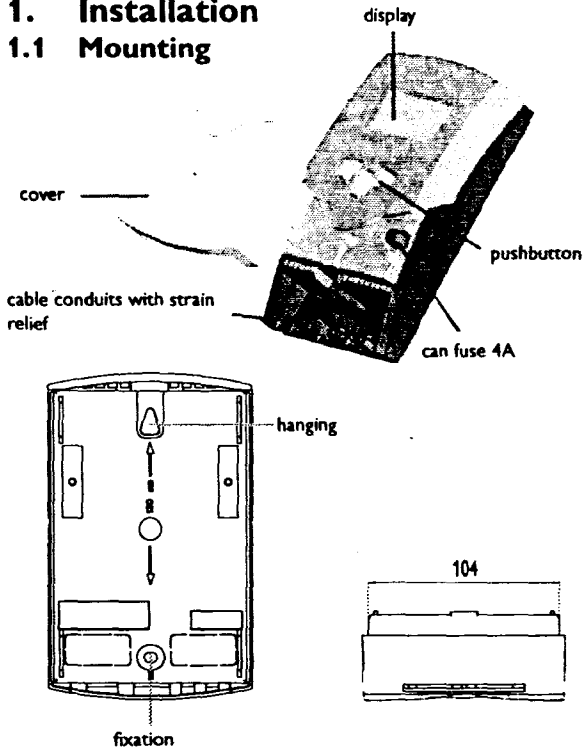

Warning!
Switch-off power supply before opening the housing.

The unit must only be located internally. It is not suitable for installation in hazardous locations and should not be sited near to any electromagnetic field. The controller must additionally be equipped with an all-polar gap of at least 3 mm or with a gap according to the valid installation regulations, e.g. LS-switches or fuses. Please pay attention to a separate laying of the cable lines and installation of ac power supply.

1. Unscrew the cross-recessed screw of the cover and remove it from the housing.
2. Mark the upper fastening point on the wall and pre-mount the enclosed dowel and screw.
3. Hang up the housing at the upper fastening point and mark the lower fastening point on the underground (hole distance 130 mm), afterwards put the lower dowel.
4. Fasten the housing at the underground.

1.2 Electrical connection

PG 66.30 and 67.30

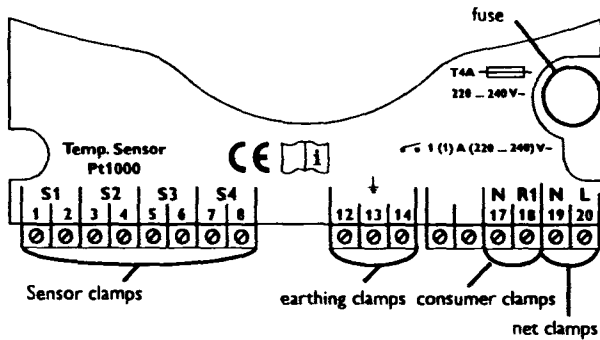

PG 68.30 and 69.30

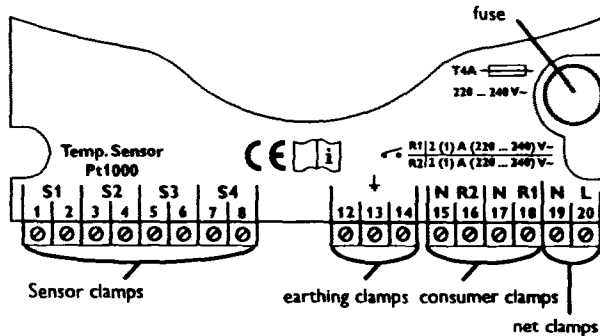

The power supply to the controller must only be made by an external power supply switch (last step of installation!) and the line voltage must be 220 ... 240 Volt (50...60 Hz). Flexible lines have to be fixed at the housing by enclosed strain relief supports and screws.

Depending on the version the controller is equipped with 1 relay (PG 66.30 and PG 67.30) or 2 relays (PG 68.30 and PG 69.30) to which the consumers e.g. pumps, valves etc. can be connected:

- Relay 1
 - 18 = conductor R1
 - 17 = neutral conductor N
 - 13 = ground clamp ⊕
- Relay 2 (PG 68.30 and 69.30)
 - 16 = conductor R2
 - 15 = neutral conductor N
 - 14 = ground clamp ⊕

The temperature sensors (S1 up to S4) will be connected to the following terminals independently of the polarity:

- 1 / 2 = Sensor 1 (e.g. Sensor collector 1)
- 3 / 4 = Sensor 2 (e.g. Sensor store 1)
- 5 / 6 = Sensor 3 (e.g. Sensor TSPO)
- 7 / 8 = Sensor 4 (e.g. Sensor TRL)

The power supply is effected to the clamps:

- 19 = neutral conductor N
- 20 = conductor L
- 12 = ground clamp ⊕



Electrostatic discharge can lead to damages of electronic components!



Dangerous voltage on contact!

1.2.1 Allocation of clamps for system 1

Standard solar system with 1 store, 1 pump and 3 sensors. The sensor S4 / TRF can optionally be used for heat quantity balancing.

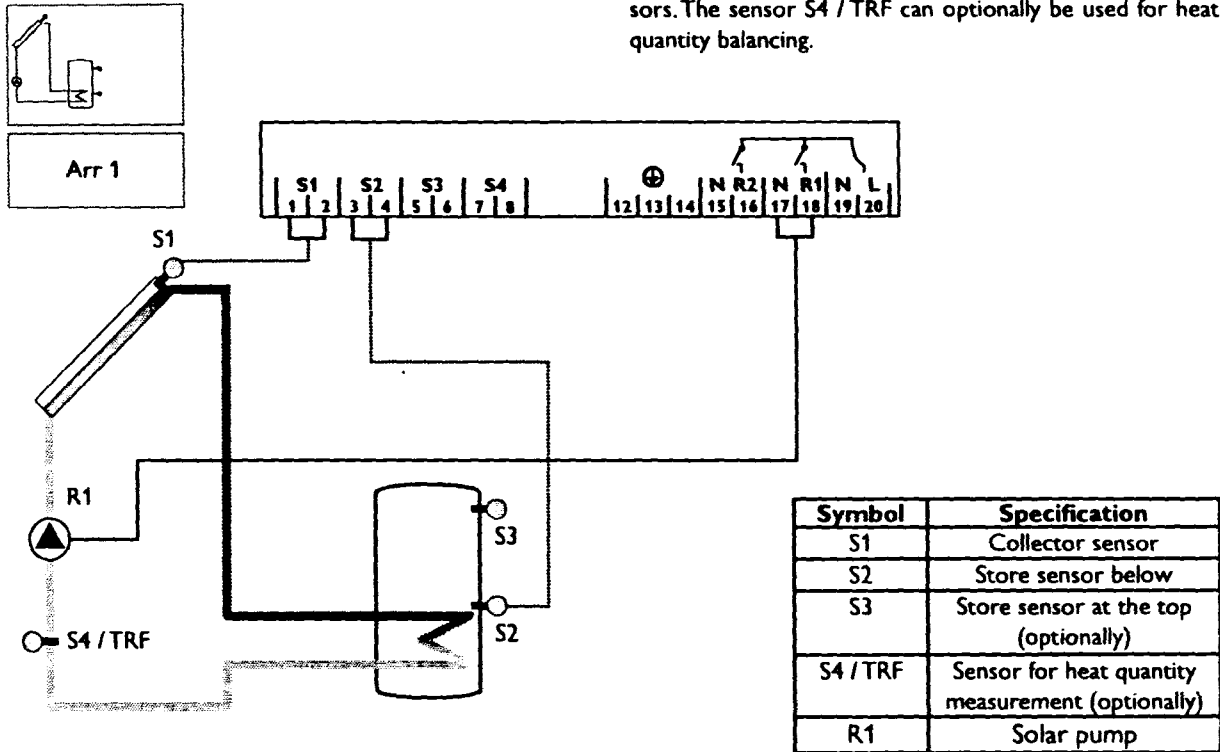

1.2.2 Allocation of clamps for system 2
(PG 68.30 and PG 69.30)

Solar system and after-heating with 1 store, 3 sensors and after-heating. The sensor S4 / TRF can optionally be used for heat quantity balancing.

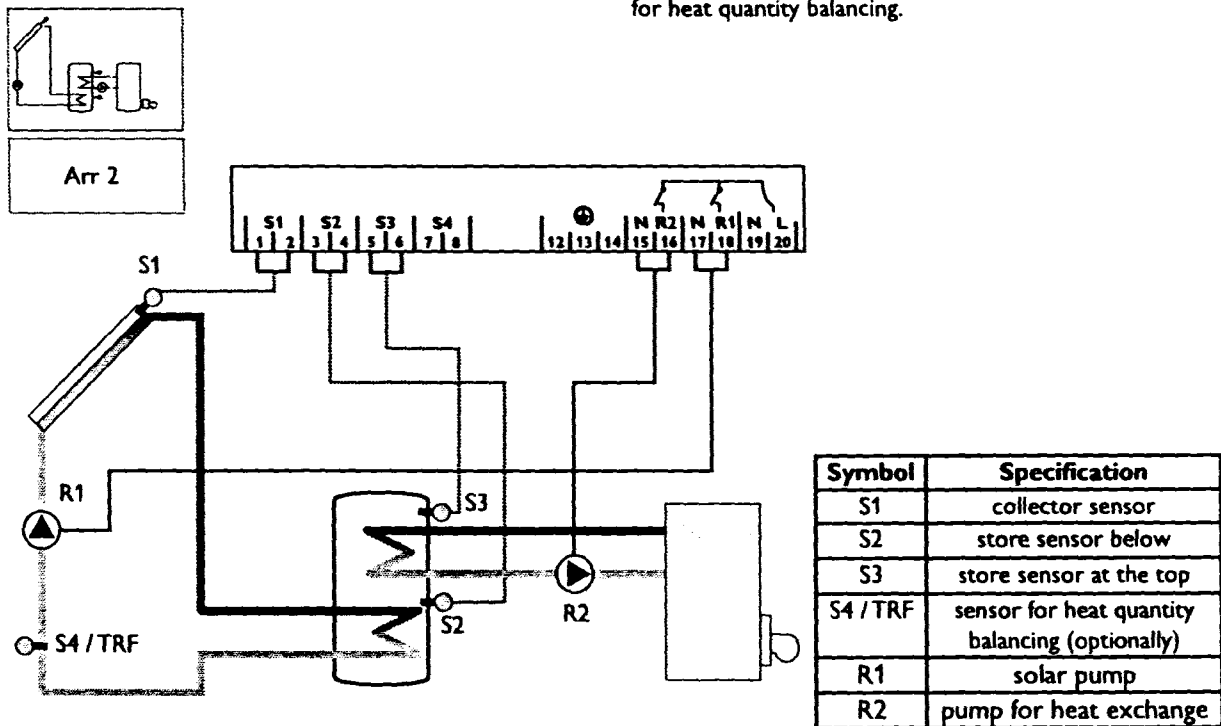

2. Operation and function

2.1 Pushbuttons for adjustment

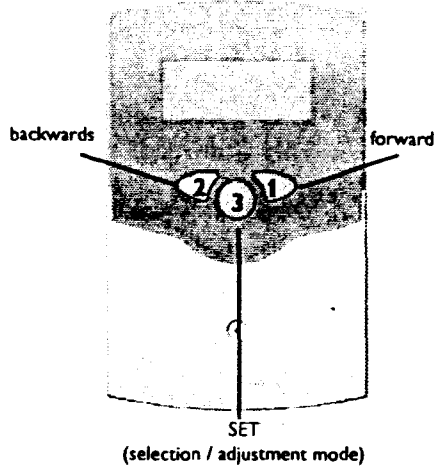

The controller is operated by 3 pushbuttons below the display. The forward-key (1) is used for scrolling forward through the indication menu or to increase the adjustment values. The backwards-key (2) is accordingly used for the reverse function.

For adjustment of last indication channel, keep button 1 pressed for 2 seconds. If an **adjustment value** is shown on the display, **SEt** is indicated. In this case you can press the key „Set“ (3) in order to change into input mode.

Select a channel by keys 1 and 2
 Shortly press key 3, so that „SEt“ flashes
 Adjust the value by keys 1 and 2
 Shortly press key 3, so that „SEt“ permanently appears, the adjusted value is now saved.

2.2 System monitoring display

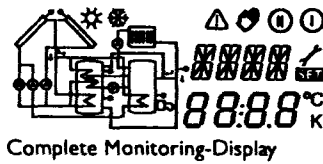

Complete Monitoring-Display

The system monitoring display consists of 3 blocks: **indication of the channel, tool bar and system screen (active system scheme).**

2.2.1 Channel indication



only channel indication

The **indication channel** consists of two lines. The upper line is an alphanumeric 16-segment indication, in which mainly the channel names / menu items are shown. In the lower 7-segment indication, the channel values and the adjustment parameter are indicated.

Temperatures and temperature differences are indicated in °C or K.

2.2.2 Tool bar



only tool bar

The additional symbols of the **tool bar** indicate the current system status.

Symbol	standard	flashing
ⓘ	relay 1 active	
Ⓐ	relay 2 active	
☀	maximum store limitation active / maximum store temperature exceeded	collector cooling function or recolling function active
☁	antifreeze- function activated	collector minimum limitation or antifreeze function active
⚠		collector security shutdown or store security shutdown active
⚠ + 🔧		sensor defect
⚠ + 🖐		manual operation active
SEt		an adjustment channel is changed SET-mode

2.2.3 System screen

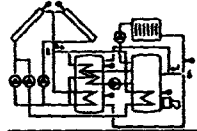

only system screen

The system screen (active system scheme) shows the schemes selected on the controller. It consists of several system component symbols, which are - depending on the current status of the system - either flashing, permanently shown or hidden.

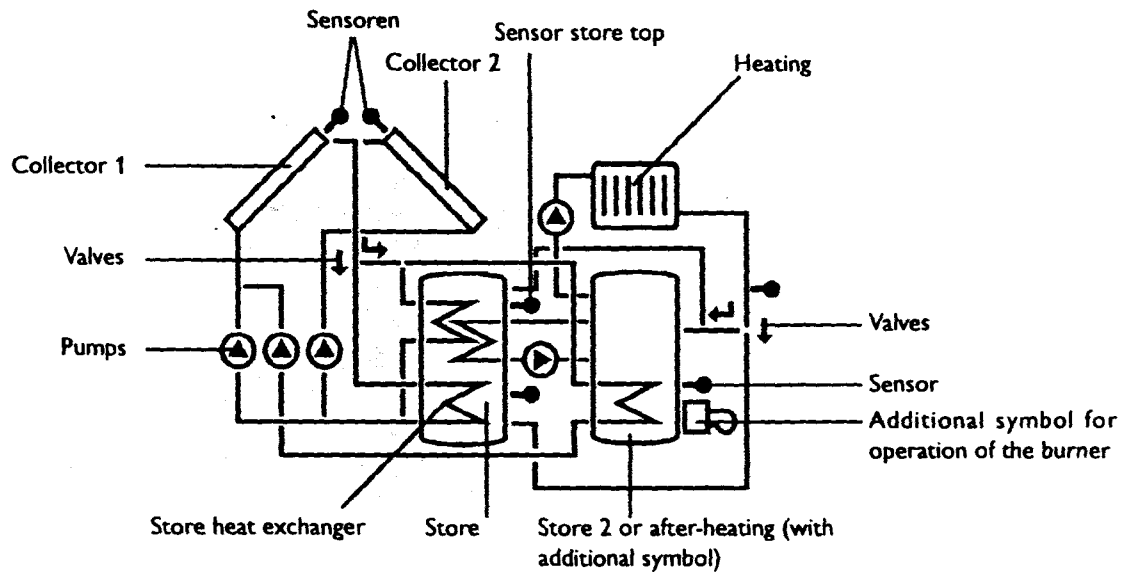

Collectors
with collector sensor

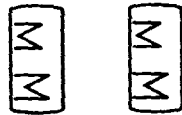

Store 1 and 2
with heat exchanger



3-way-valves
The flow direction or the current breaking capacity are always shown.



Temperature sensor



Heating circuit



Pump



After-heating
with burner symbol

2.3 Blinking codes

2.3.1 System screen blinking codes

- Pumps are blinking during starting phase
- Sensors are blinking if the respective sensor-indication channel is selected.
- Sensors are quickly blinking in case of sensor defect.
- Burner symbol is blinking if after-heating is activated.

2.3.2 LED blinking codes

- Constantly green: everything all right
 Red/green blinking: initialisation phase
 manual operation
 Red blinking: sensor defect
 (sensor symbol is quickly blinking)

3. Commissioning

On commissioning you have to adjust primarily the matching system

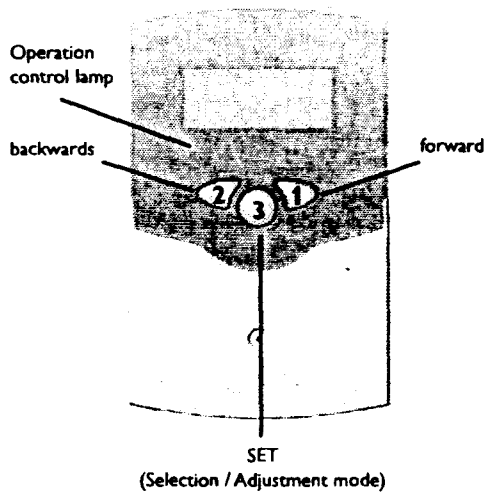

1. AC power supply must be activated. The controller passes an initialisation phase in which the operating control lamp flashes red and green. After having finished the initialisation, the controller is in automatic operation with factory settings. The preadjusted system scheme is Arr 1.

2. - select Arr

- change into **SET**-mode (see 2.1)
- select the system scheme by Arr-characteristics
- adjustment is saved by pressing button **SET**

Now the controller is ready for operation and should enable an optimum operation of the solar system by the factory settings made.

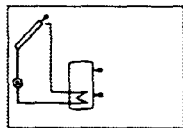

Arr 1

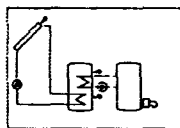

Arr 2

System survey:

Arr 1 : standard solar system

Arr 2 : solar system with after-heating
(PG 68.30 and PG 69.30)

4. Controller parameter and indication channels

4.1 Channel-overview

Legend:

x

Corresponding channel is available.

x^{*}

Corresponding channel is available if the appropriate option is activated.

①

Only by PG 67.30 and 69.30

Please note:

S3 and S4 are only indicated if sensors are connected.

①

Corresponding channel is only available if the option heat quantity measurement is **activated** (OHQM).

②

Corresponding channel is only available if the option heat quantity measurement is **deactivated** (OHQM).

MEDT

The channel antifreeze content (MED%) is only shown if a medium other than **water or Tyfocor LS / G-LS (MEDT 0 or 3)** is used. The adjustment is only appropriate when using other types of antifreeze.

channel	Arr		specification	page
	1	2*		
COL	x	x	Temperature collector 1	11
TST	x		Temperature store 1	11
TSTL		x	Temperature store 1 below	11
TSTU		x	Temperature store 1 above	11
S3	x		Temperature sensor 3	11
TRF	①	①	Temperature return sensor	11
S4	②	②	Temperature sensor 4	11
n %	x		Pump speed relay 1	11
n1 %		x	Pump speed relay 1	11
h P	x		Operating hours relay 1	11
h P1		x	Operating hours relay 1	11
h P2		x	Operating hours relay 2	11
kWh	①	①	Heat quantity kWh	12
MWh	①	①	Heat quantity MWh	12
Arr	1-2		System	9
DT O	x	x	Switch-on temperature difference	13
DT F	x	x	Switch-off temperature difference	13
DT S	x	x	Nominal temperature difference	13
RIS	x	x	Increase	13
S MX	x	x	Maximum temperature store 1	13
EM	x	x	emergency temperature collector 1	14

channel	Arr		specification	page
	1	2		
OCX	x	x	Option collector cooling collector 1	14
CMX	x*	x*	Maximum temperature collector 1	14
OCN	x	x	Option minimum limitation collector 1	14
CMN	x*	x*	Minimum temperature collector 1	14
OCF	x	x	Option antifreeze collector 1	14
CFR	x*	x*	Antifreeze temperature collector 1	14
OREC	x	x	Option recolling	15
OTC	x	x	Option tube collector	15
AH O		x	Switch-on temp. for thermostat 1	15
AH F		x	Switch-off temp. for thermostat 1	15
OHQM		x	Option WMZ	12
FMAX	①	①	Maximum flow	12
MEDT	①	①	Antifreeze type	12
MED%	MEDT	MEDT	Antifreeze content	12
nMN	x		Minimum pump speed relay 1	16
n1MN		x	Minimum pump speed relay 1	16
HND1	x	x	Manual operation relay 1	16
HND2	x	x	Manual operation relay 2	16
LANG	x	x	Language	16
PROG	XX.XX		Program number	
VERS	X.XX		Version number	

* System 2 applies only for the version 68.30 and 69.30

4.1.1 Indication of collector temperatures

COL:
Collector temperature
display range: -40...+250 °C

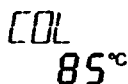

Shows the current collector temperature.
• COL : collector temperature (1-collector-system)

4.1.2 Indication of store temperatures

TST,TSTL,TSTU:
Store temperatures
Display range: -40...+250 °C

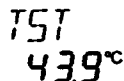

Shows the current store temperature.
• TST : store temperature (1-store-system)
• TSTL : store temperature lower
• TSTU : store temperature upper

4.1.3 Indication of sensor 3 and sensor 4

S3, S4:
Sensor temperatures
Display range: -40...+250 °C

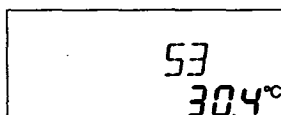

Shows the current temperature of the corresponding additional sensor (without control function).
• S3 : temperature sensor 3
• S4 : temperature sensor 4
Please note:
S3 and S4 are only indicated if the temperature sensors are connected (shown).

4.1.4 Indication of other temperatures

TRF:
other measured
temperatures
Display range: -40...+250 °C

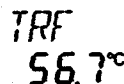

Shows the current temperature of the sensor.
• TRF : temperature return flow

4.1.5 Indication of current pump speed

n %, n1 %:
current pump speed
Display range: 30...100 %
(PG 67.30 and PG 69.30)

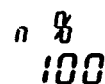

Shows the current pump speed of the corresponding pump.
• n % : current pump speed (1-pump-system)
• n1 % : current pump speed pump 1

4.1.6 Operating hours counter

h P / h P1 / h P2:
Operating hours counter
Display channel

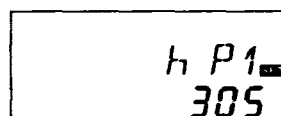

The operating hours counter adds up the solar operating hours of the respective relay (h P / h P1 / h P2). Full hours are shown on the display.
The operating hours added up can be reset. As soon as one operating hours channel is selected, the symbol **h P1** is permanently shown on the display. The button SET (3) must be pressed for approx. 2 seconds in order to get back into the RESET-mode of the counter. The display-symbol **h P1** is flashing and the operating hours will be set to 0. In order to finish the RESET-procedure, the button **h P1** must be pressed in order to confirm.
In order to interrupt the RESET-procedure, no button should be pressed for about 5 seconds. The controller returns automatically into the indicator mode.

4.1.7 Heat quantity balancing

OHQM:Heat quantity balancing

Adjustment range: OFF...ON

Factory setting: OFF

FMAX:

Volume flow in l/min

Adjustment range 0...20
in steps of 0,1

Factory setting 6,0

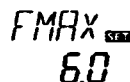
A heat quantity balancing is possible for all systems in conjunction with a flowmeter. You just have to activate the option heat quantity balancing in the channel **OHQM**.

The volume flow readable at the flowmeter (l/min) must be adjusted in the channel **FMAX**. Antifreeze type and concentration of the heat transfer medium are indicated on the channels **MEDT** and **MED%**.

MEDT: Type of antifreeze

Adjustment range 0...3

Factory setting 1

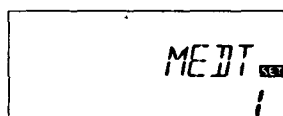

MED%: Concentration of antifreeze in (Vol-) %

MED% is blinded out by MEDT 0 and 3.

Adjustment range 20...70

Factory setting 45



kWh/MWh:Heat quantity

in kWh / MWh

Display channel

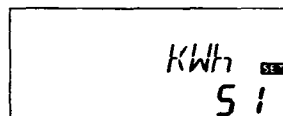

Type of antifreeze:

0 : water

1 : propylene glycol

2 : ethylene glycol

3 : Tyfocor® LS / G-LS

The heat quantity transported is measured by the indication of the volume flow and the reference sensor of feed flow S1 and return flow S4. It is shown in kWh-parts in the indication channel **kWh** and in MWh-parts in the indication channel **MWh**. The sum of both channels form the total heat output.

The heat quantity added up can be reset. As soon as one of the display channels of the heat quantity is selected, the symbol **SET** is permanently shown on the display. The button SET (3) must be pressed for approx. 2 seconds in order to get back into the RESET-mode of the counter. The display-symbol **SET** is flashing and the value for heat quantity will be set to 0. In order to finish the RESET-procedure, the button **SET** must be pressed for confirmation.

In order to interrupt the RESET-procedure, no button should be pressed for about 5 seconds. The controller returns automatically into indication mode.

4.1.8 ΔT -regulation**DT O:**

Switch-on temperature
Adjustment range 1,0...20,0K
Factory setting 6.0

DT O SET
6.0 K

DT F:

Switch-off temperature diff.
Adjustment range
0,5 ... 19,5K
Factory setting 4.0 K

DT F SET
4.0 K

Please note: Switch-on temperature difference DO must be at least 1 K higher than the switch-off temperature-difference DF.

DT S:

Nominal temperature difference
Adjustment range 1,5...30,0K
Factory setting 10.0
(PG 67.30 and 69.30)

DT S SET
10.0 K

RIS:

Raise
Adjustment range 1 ... 20K
Factory setting 2 K
(PG 67.30 and PG 69.30)

RIS SET
2.0 K

Primarily the controller works in the same way as a standard differential controller. If the switch-on difference (**DT O**) is reached, the pump is activated and after having got an impulse (10 s) a minimum pump speed (nMN = 30 %) is run. If the adjusted nominal value of the temperature difference (**DT S**) (only PG 67.30 and PG 69.30) is reached, the pump speed is increased by one step (10%). If the difference increases by 2 K (**RIS**) (only PG 67.30 and PG 69.30), the pump speed is increased by 10 % respectively until the maximum pump speed of 100 % is reached. The response of the controller can be adapted by means of the parameter „Raise“. If the adjusted switch-off temperature is underrun (**DT F**), the controller switches-off.

4.1.9 Maximum store temperature

S MX:

Maximum store temp.
Adjustment range 2...95 °C
Factory setting 60 °C

S MX SET
60 °C

If the adjusted maximum temperature is exceeded, a further loading of the store is stopped so that a damaging overheating can be avoided. If the maximum store temperature is exceeded, on the display * is shown.

Please note: The controller is equipped with a security-switch-off of the store, which avoids a further loading of the store if 95 °C are reached at the store.

4.1.10 Limit collector temperature Collector emergency shutdown

EM:

Limit collector temperature
Adjustment range
110 ... 200 °C,
Factory setting 140 °C

EM
140°C

If the adjusted collector limit temperature (**EM**) is exceeded, the solar pump (R1/R2) is deactivated in order to avoid a damaging overheating of the solar components (collector emergency shutdown). The limit temperature is set to 140 °C by but it can be changed within the adjustment range of 110 ... 200 °C. In the display is shown Δ (flashing).

4.1.11 System cooling

OCX:

Option system cooling
Adjustment OFF ... ON
Factory setting OFF

OCX
OFF

CMX:

Maximum collector temp.
Adjustment range
100 ... 190 °C
Factory setting 120 °C

CMX
120°C

If the adjusted maximum store temperature is reached, the solar system switches-off. If now the collector temperature raises to the adjusted maximum collector temperature (**CMX**), the solar pump remains activated until this limit temperature value is again underrun. The store temperature might continue to raise (subordinated active maximum store temperature), but only until 95 °C (emergency shutdown of the store). If the store temperature is higher than the maximum store temperature (**SMX**) and the collector temperature is lower by at least 5 K than the store temperature, the solar system remains activated until the store is again cooled down by the collector and the tubes under the adjusted maximum temperature (**SMX**).

In case of active system cooling on the display is shown \star (flashing). Due to the cooling function the solar system can be kept operable for a longer period on hot summer days and a thermal release of the collector and the heat transfer medium is ensured as well.

4.1.12 Option minimum collector limitation

OCN:

Minimum collector limitation
Adjustment range OFF / ON
Factory setting OFF

OCN
OFF

CMN:

Minimum collector temperature Adjustment range
-10 ... 90 °C
Factory setting 10 °C

CMN
10.0°C

The minimum collector temperature is a minimum switching temperature, which must be exceeded so that the solar pump (R1/R2) is switched-on. The minimum temperature shall avoid a steady starting-up of the solar pump (or solid fuel boiler charging pumps) for low collector temperatures. If the minimum temperature is underrun, in the display is shown \star (flashing).

4.1.13 Option antifreeze function

OCF:

Antifreeze function
Adjustment range
OFF / ON
Factory setting OFF

OCF
OFF

CFR:

Antifreeze temperature
Adjustment range
-10 ... 10 °C
Factory setting 4,0 °C

\star

CFR
4°C

The antifreeze function activates the loading circuit between collector and store if the adjusted antifreeze function is underrun in order to protect the medium that it will not freeze or „get thick“. If the adjusted antifreeze temperature is exceeded by 1 °C, the loading circuit will be deactivated.

Please note:

As there is only a limited heat quantity of the store available for this function, the antifreeze function should only be used in regions with few days of temperatures around freezing point.

4.1.14 Recooling function

OREC:

option recooling
adjustment range
OFF...ON
Factory setting: OFF

OREC ^{OFF}
OFF

If the adjustable maximum store temperature (**S MX**) is reached, the solar pump remains activated in order to avoid an overheating of the collector. The store temperature might continue to increase but only up to 95 °C (emergency shutdown of the store). In the evening the solar system continues running until the store is cooled down to the adjusted maximum store temperature via collector and pipes.

4.1.15 Tube collector special function

OTC:

Tube collector special
function
Adjustment range:
OFF...ON
Factory setting: OFF

OTC ^{OFF}
OFF

If the controller measures an increase of 2 K compared to the collector temperature stored at last, the solar pump is switched-on to 100 % for about 30 seconds. After expiration of the solar pump runtime the current collector temperature is stored as new reference value. If the measured temperature (new reference value) is again exceeded by 2 K, the solar pump again switches-on for 30 seconds. If the switch-on difference between collector and store is again exceeded during runtime of the solar pump or the standstill of the system, the controller automatically switches over to solar charging. If the collector temperature drops by 2 K during standstill, the switch-on value for the special tube collector function will be recalculated.

4.1.16 Thermostat function

(Arr = 2)

after-heating

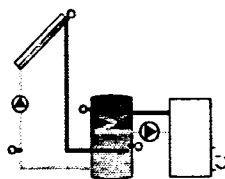

use of surplus energy

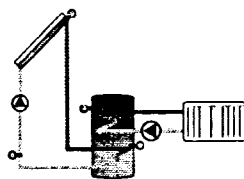

The thermostat function works independently from the solar operation and can e.g. be used for use of surplus energy or an after-heating.

- **AH O < AH F**
the thermostat function is used for after-heating
- **AH O > AH F**
the thermostat function is used for use of surplus energy

On the display is shown  if the second relay output is activated.

AH O ^{OFF}
40.0 °C

AH O:
Thermostat-switch-on
temperature
Adjustment range:
0,0...95,0 °C
Factory setting: 40,0 °C

AH F ^{OFF}
45.0 °C

AH F:
Thermostat-switch-off tem-
perature
Adjustment range:
0,0...95,0 °C
Factory setting: 45,0 °C

4.1.17 Pump speed control

nMN:

Pump speed control

Adjustment range:

30...100

Factory setting: 30

(PG 67.30 and PG 69.30)



A relative minimum pump speed is specified for pumps connected at the outputs R1 and R2 via adjustment channel nMN.

Attention:

When using consumers (e.g. valves) which are not pump speed controlled, the value must be adjusted to 100% in order to deactivate the pump speed control.

4.1.18 Operating mode

HND1 / HND2:

Operating mode

Adjustment range:

OFF,AUTO,ON

Factory setting:AUTO



For control and service work the operating mode of the controller can be manually adjusted by selecting the adjustment value HND1 / HND2, in which the following adjustments can be made:

• **HND1 / HND2**

Operating mode

- OFF : relay off ⚠ (flashing) + 🖱
- AUTO : relay in automatic operation
- ON : relay on ⚠ (flashing) + 🖱

4.1.19 Language

LANG:

Adjustment of language

Adjustment range:

dE, En, It, Fr

Factory setting: En

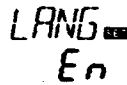

The menu language can be adjusted in this channel.

- dE : German
- En : English
- It : Italiano
- Fr : French

5. Tips for fault localization

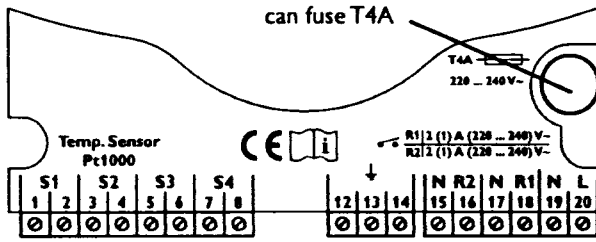

If a malfunction occurs, a notification is given on the display of the controller:

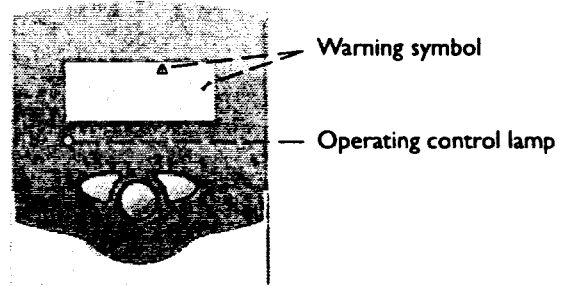

Operating control lamp flashes red. On the display appears the symbol ⚡ and the symbol ⚠.

Operating control lamp off

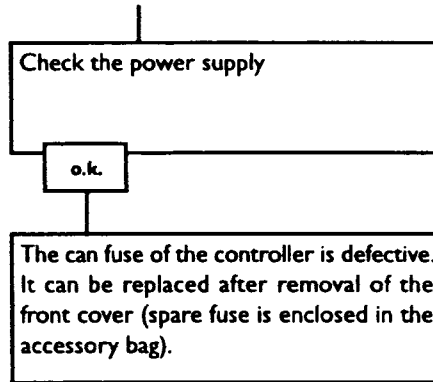
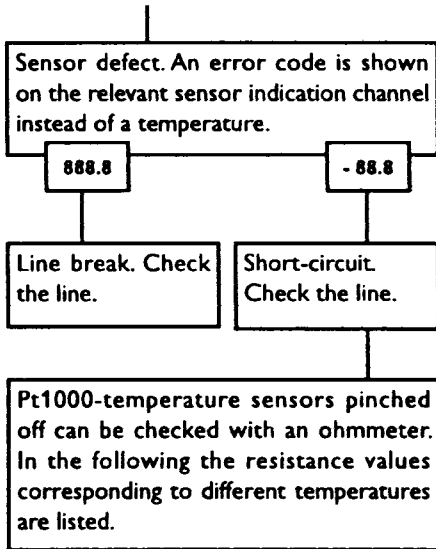

°C	Ω	°C	Ω
-10	961	55	1213
-5	980	60	1232
0	1000	65	1252
5	1019	70	1271
10	1039	75	1290
15	1058	80	1309
20	1078	85	1328
25	1097	90	1347
30	1117	95	1366
35	1136	100	1385
40	1155	105	1404
45	1175	110	1423
50	1194	115	1442

Resistance values of the Pt1000-sensors

5.1 Various:

Pump is overheated, but no heat transfer from collector to the store, feed flow and return flow are equally warm, possibly also bubble in the tubes

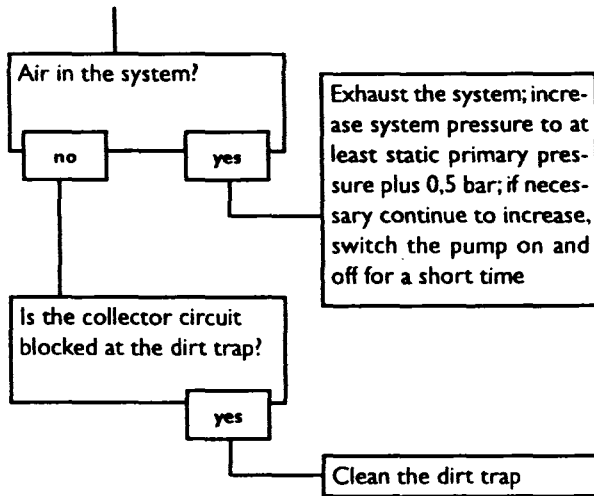

Pump starts for a short moment, switches-on/off repeatedly

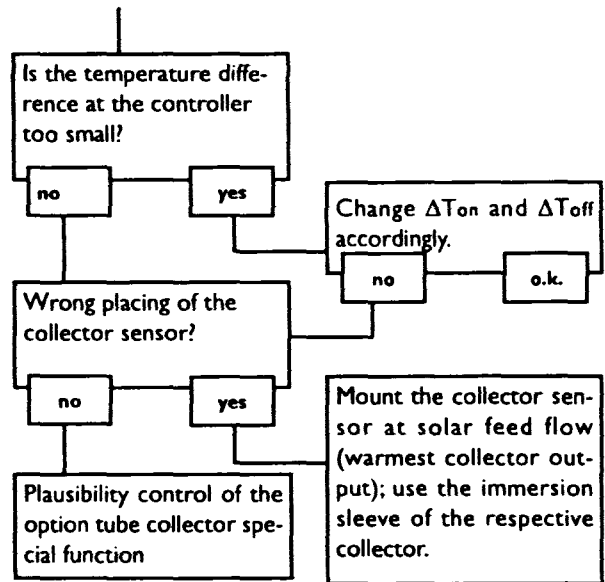

Pump starts up very late and stops working soon.

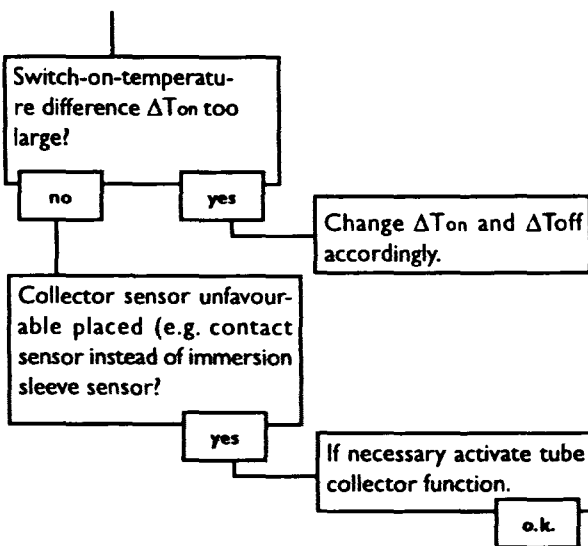

The temperature difference between store and collector increases enormously during operation; the collector circuit cannot dissipate the heat.

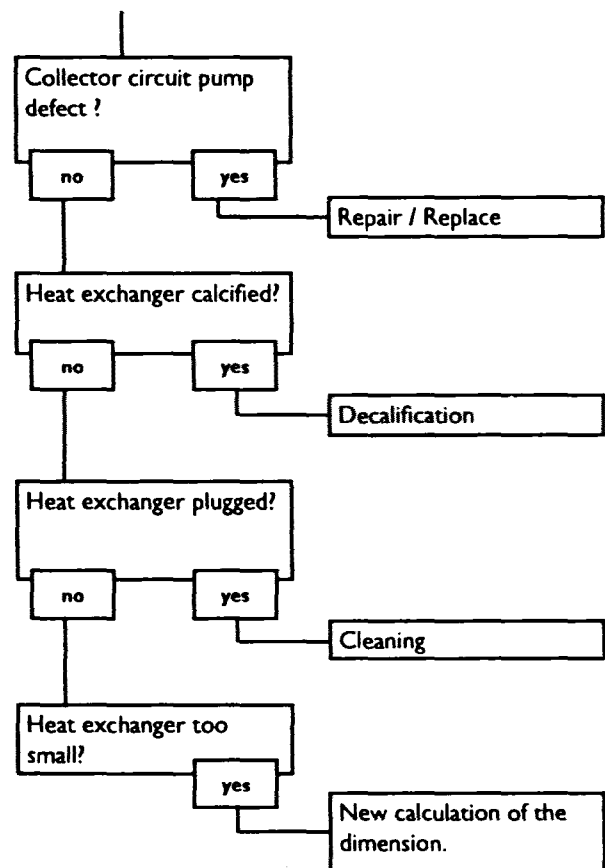

Stores are cooled during the night.

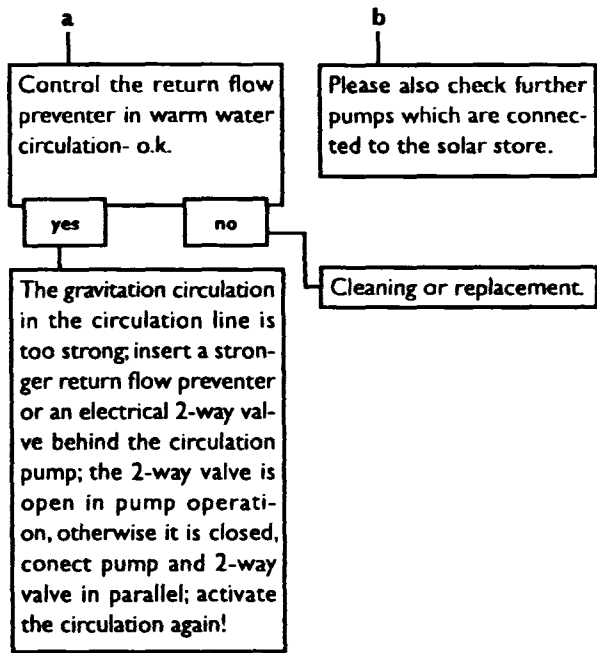
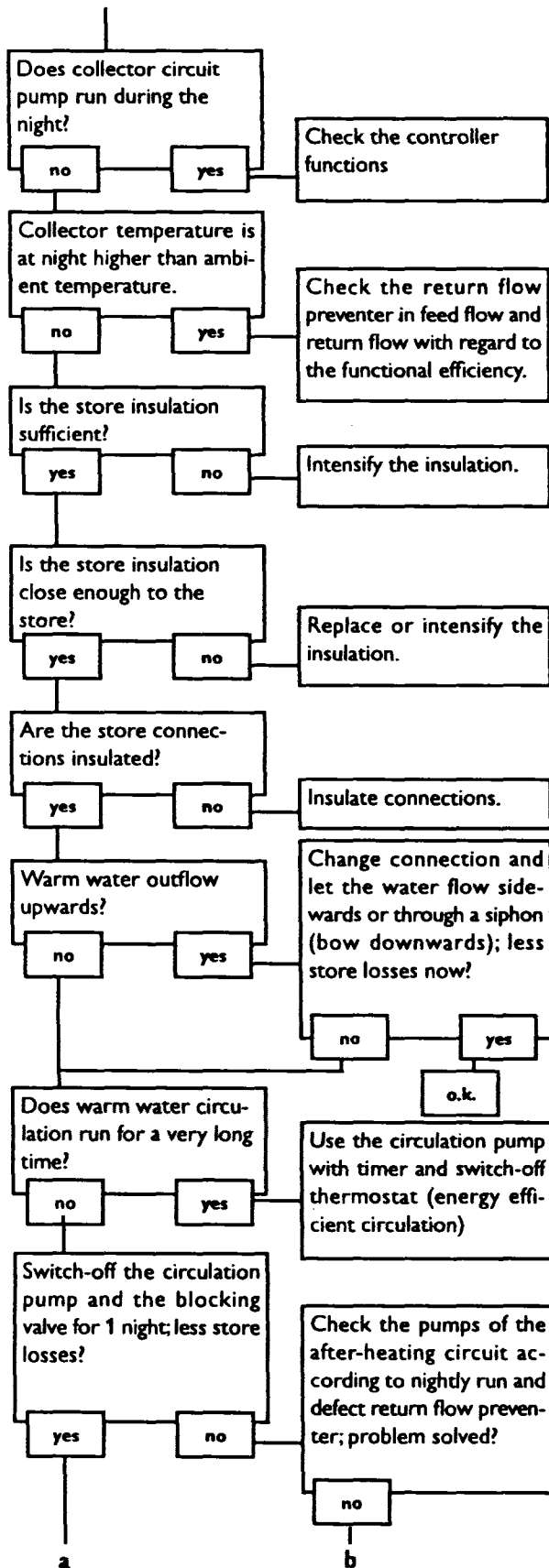

The solar circuit pump does not work although the collector is obviously warmer than the store.

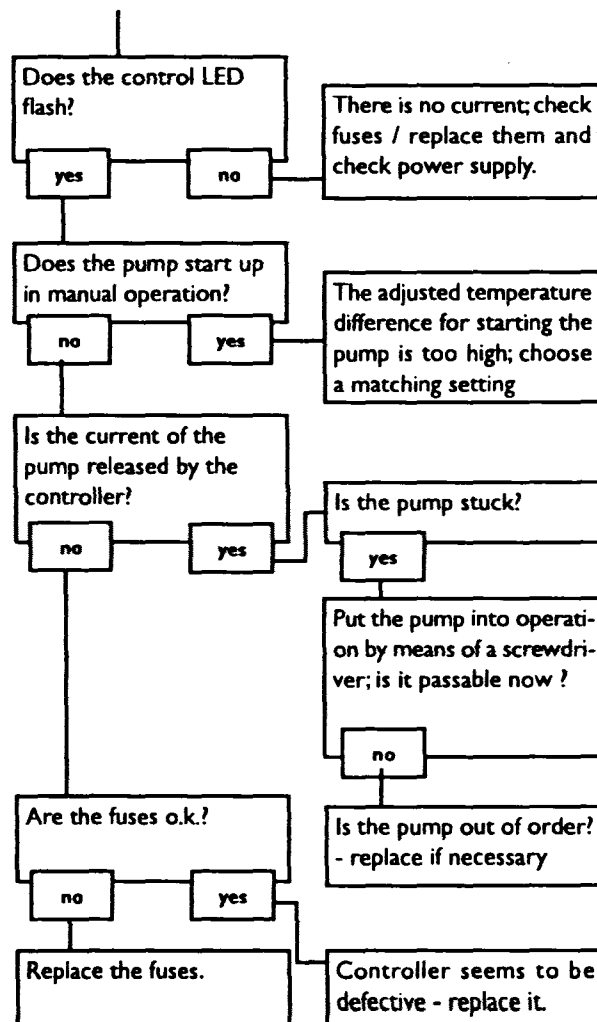

6. Accessory

Sensors

Our product range includes high-precision platinum temperature sensors, flatscrew sensors, ambient temperature sensors, indoor temperature sensors, cylindrical clip-on sensors and irradiation sensors, also to be used as full sensors with sensor pocket.



Overvoltage protection

We highly recommend to install the overvoltage protection in order to avoid overvoltage damages at the collector (e.g. by lightning).



Flowmeter

If you are interested in realising a heat quantity balancing, you need a flowmeter for measuring the volume flow in your system.



Distributed by:

Altecnic Ltd.

Airfield Industrial Estate

Hixon

Staffs

St18 0PF

UK

Tel.: +44 (0)1889 207200

Fax: +49 (0) 23 24 / 96 48 - 755

www.altecnic.co.uk

sales@altecnic.co.uk

Reprinting / copying

This mounting- and operation manual including all parts is copyrighted. Another use outside the copyright requires the approval of Altecnic Ltd.. This especially applies for copies, translations, micro films and the storage into electronic systems. Editor: Altecnic Ltd.

Important notice:

We took a lot of care over the texts and drawings of this manual and to the best of our knowledge and consent. As faults can never be excluded, please note: Your own calculations and plans under consideration of the current norms and DIN-directions should only be basis for your projects. We don't offer a guarantee for the completeness of the drawings and texts of this manual - they only represent some examples. They can only be used on own risk. No liability is assumed for incorrect, incomplete or false information and the resulting damages.

Errors and technical changes excepted.

Please note:

The design and the specifications are to be changed without notice.

The illustrations may differ from original product.